









Bird's Nest Tree Midi

Art. No. 4652-10 Wood crossbeams

Art. No. 4652-10S Steel crossbeams



For symbol explanation see folding card at the back

-  5.20 m
-  Ø 3.65 m
-  44.20 m³
-  Ø 7.50 m
-  2.00 m
-  3.00 m³
-  35
- 

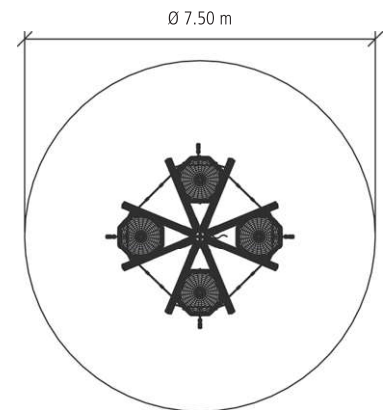
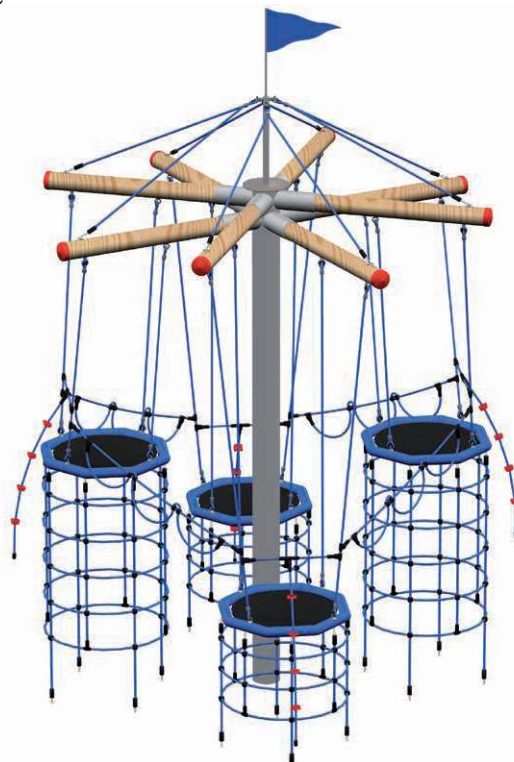

Q Mini Bird's Nest Tree (Page 17)

Q Bird's Nest Tree (Page 89)

Hot-dipped galvanised steel cross beams are available upon request. Further elements such as a slide can be added.

