

# **A Assembly Instructions**

## **Dino Mini , Art.-Nr. 10.05.100**

**Attention! Only use the assembly instruction included in the scope of delivery for the assembly, installation and maintenance of the respective equipment!**

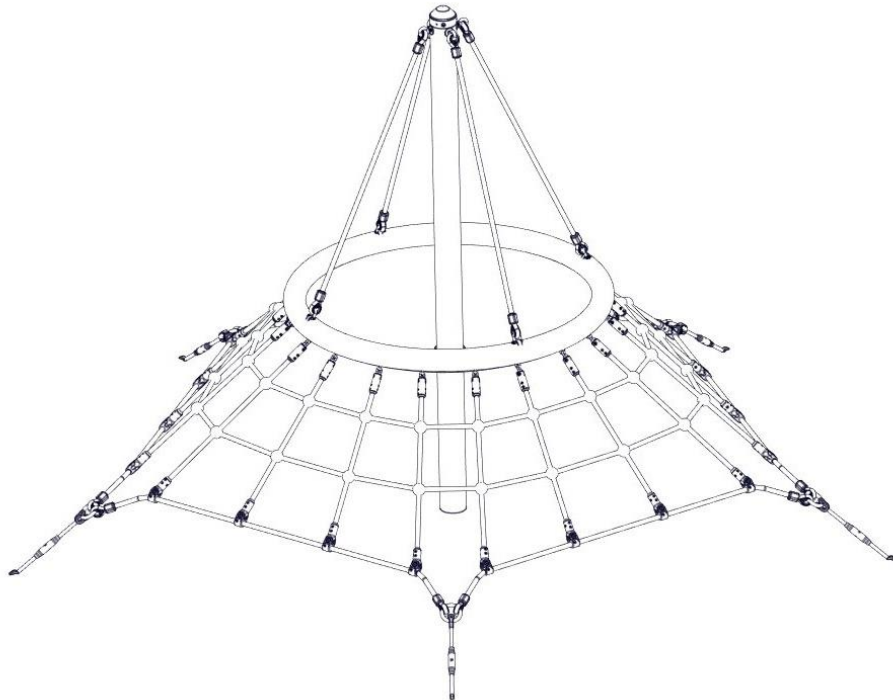

**Operator:** \_\_\_\_\_

**Location:** \_\_\_\_\_

Revision 0 – 2011-02-23  
Erste freigegebene Version  
Montageanleitung FH  
Revision 5– 2021-08-09  
neue Form der Anleitung FH  
Alle Rechte vorbehalten  
© Copyright 2010 Huck Seiltechnik GmbH

Index of contents

<b>A</b>	<b>Assembly Instructions Dino Mini , Art.-Nr. 10.05.100 .....</b>	<b>1</b>
1	Introduction Assembling .....	4
2	Data sheet Rope Net Pyramid, DINO Mini, Article No. 10.05.100 .....	5
3	Content, numbered bill of materials .....	6
4	Installation instruction.....	10
5	Post installation checks .....	16
<b>B</b>	<b>Maintenance Instructions Dino Mini, Art.-Nr. 10.05.100 .....</b>	<b>17</b>
6	Introduction Maintenance.....	19
7	General maintenance information .....	20
8	Maintenance timetable.....	22
9	Regular maintenance.....	23
10	Monthly maintenance .....	24
11	Quarterly maintenance .....	24
12	Half yearly maintenance .....	25
13	Annual maintenance .....	25
14	Maintenance printout.....	26
15	Hand over document .....	27

**Index of schedules**

Schedule 3-1: Delivery content, numbered bill of materials .....	6
Schedule 3-2: Contents, numbered bill of materials .....	7

---

## 1 Introduction Assembling

### 1.1 General information

This equipment should be installed, inspected, maintained and operated in accordance with EN1176-7 guidelines.

**Before installation work commences, please check that you have all of the equipment and fixation components in the parts list provided (see Tables 3-1 and 3-2).**

**Please consider that the installation has to be carried out only on even terrain (max.slope up to 3%).**

Any spare parts that may be required can be obtained directly from your supplier.

Please do not hesitate to call your supplier if you have any problems during installation or in case of any other questions.



**Attention**

Following installation, complete assembly instructions, maintenance instructions and a maintenance record must be sent to the operator who must confirm receipt in writing. See the last page of this document.



**Attention**

All nuts and bolts are hot-dip galvanised or stainless steel.

One of the characteristics of stainless steel is that uncontrolled cold welding may occur when the nuts are tightened. To prevent this, it is necessary to spray the nuts and bolts with Teflon spray or another similar lubricant.

---

**We hereby confirm that this play equipment has been tested and certified in accordance with the play equipment standard EN 1176-1:2017.**

## 2 Data sheet Rope Net Pyramid, DINO Mini, Article No. 10.05.100

1. Safety zone: 5.80 m x 5.65 m  
 Installation zone: 3.45 m x 3.25 m  
 Height of fall: 0.80 m  
 Total ground height: 2.24 m  
 Fall protection area: 25 m<sup>2</sup>
2. Required safety surface:

Surface material mm	Description	Minimum thick- ness of layer mm	Maximum height of fall mm
Topsoil grass			<= 1000*
Chipped bark	20 – 80 grain size	300	<= 2000
		400	<= 3000
Wood chippings	5 – 30 grain size	300	<= 2000
		400	<= 3000
Sand	0.2 – 2 grain size	300	<= 2000
		400	<= 3000
Gravel	2 – 8 grain size	300	<= 2000
		400	<= 3000
Other surface mate- rials	As recommended by manufacturer		

3. Name and overall dimension of the largest item of equipment:  
 Steel post (1 piece) length 3.00 m, ø 193 mm
4. Name and weight of the heaviest item of equipment:  
 Steel post (1 piece) ~ 50 kg
5. Designed for age group: from 3 years and older
6. **Attention! System with concrete foundation**  
 Concrete: C25/30  
 Foundation/Excavation:  
 Top edge of concrete: 8 times 70 cm below ground level  
**1 time: 1.40 m long x 1.40 m wide, depth: 1.10 m incl.10 cm rubble drain bed**  
**8 times:0.80 m long x 0.80 m wide, depth:1.10 m incl.10 cm rubble drain bed**
7. **Round off foundation edges (min.R = 100 mm)! Sizes of foundations are “4-5” (natural ground). Soil class 4: soft to medium plasticity, interleave bound, with minor portion of stone (portion < 30% with bigger diameter of 63 mm grain size). Soil class 5: ground with soil class 3 and 4 with big portion of stones (portion > 30% with bigger diameter of 63 mm grain size).In case of sandy and soft soils, the surface measure of foundations have to be enlarged for about 50%!**
8. Required assembly time, once foundations complete:  
 approx. 7 - 8 hours. Required assistance: 2 – 3 persons.
9. Any spare parts which may be needed can be obtained directly from your supplier
10. **We hereby confirm that this item of play equipment has been tested and certified in accordance with the play equipment standard EN 1176-1:2017.**



### 3 Content, numbered bill of materials





#### 3.1 In words



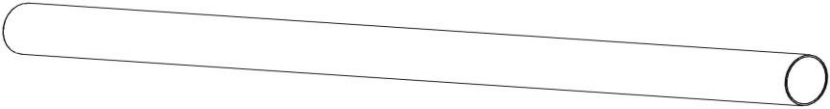
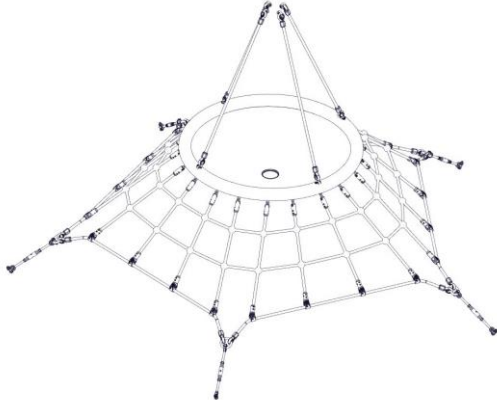

Schedule 3-1: Delivery content, numbered bill of materials

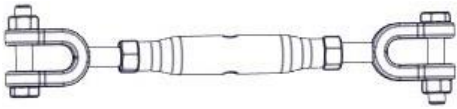
Pos.	Quantity	Element / Description	Size	O.K.	Missing
1	1	steel post	Ø 101,6 mm – 3,00 m lg		
2	1	playing part (pre-assembled)			
3	1	post cap	Ø 101,6 mm		
4	3	self-cutting screw	3,5 x 20 mm		
102	5	turnbuckle (pre-assembled)	M12		
103	5	7mm chain ~ 1,10 m			
104	5	ground anchor (plastic)	~ 300 mm long		
104a	5	6er shackle			
105	1	Loctite			
106	4	ring nut (pre assembled)	M10		
107	8	washer	for M10		
108	4	hexagon screw	M10 x 20 mm		

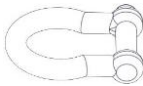
### 3.2 in Symbols

Schedule 3-2: Contents, numbered bill of materials

Pos.	Quantity	Symbol
1	1	 <p>steel post, Ø 101,6 x 3000 mm</p>
2	1	 <p>playing part (pre-assembled)</p>
3	1	 <p>for Ø 101,6 mm</p>
4	3	 <p>3,5 x 20 mm</p>
102	5	 <p>(pre-assembled) M12</p>
103	5	 <p>7er chain ~ 1,10 m</p>
104	5	 <p>ground anchor (plastic) ~ 300 mm long</p>
104a	5	 <p>curved shackle 6er</p>

Pos.	Quantity	Symbol
105	1	 <p data-bbox="815 456 911 488">Loctite</p>
106	4	 <p data-bbox="628 667 1098 698">Ringmutter M10 (pre-assembeld)</p>
107	8	 <p data-bbox="807 882 919 913">for M10</p>
108	4	 <p data-bbox="644 1164 1082 1196">Hexagon screw M10 x 20 mm</p>



	<b>Dino mini version</b>
<b>AB</b>	The legally prescribed setting time must be observed
<b>B</b>	Cross bar provided by the customer to fix the anchor chain during concreting
<b>D</b>	Concrete C25/30
<b>Ek</b>	Chains are to be shortened during assembly. (if required)
<b>F</b>	Fall protection
<b>G</b>	Drainage layer
<b>KNR</b>	KNR - Empty pipe (e.g. concrete sewer pipe or PVC Ø 200 mm / 0.45 m long / by the customer)
<b>LRB</b>	Fill the gap (between empty pipe and steel pole) with liquid concrete!
<b>O.K</b>	Upper edge of play level
<b>PS</b>	Safety area 25 m <sup>2</sup>
<b>VO</b>	pre-assembled
	<p><u>Top edges of concrete rounded! Foundation dimensions apply to normal soil classes 4-5 (grown soil).</u></p> <p><u>Soil class 4: Light to medium plasticity, interconnected, with low stone content (proportion &lt; 30 % above a diameter of 63 mm grain size).</u></p> <p><u>Soil class 5: Soils of soil classes 3 and 4 with a large proportion of stones (proportion &gt; 30 % above a diameter of 63 mm grain size).</u></p> <p><u>For safety reasons, the foundations of sandy, soft soils should be at least 50% larger in area.</u></p> <p><u>Translated with <a href="http://www.DeepL.com/Translator">www.DeepL.com/Translator</a> (free version)</u></p>
<b>M.Lot !!</b>	Make sure to set up the mast/post perpendicularly!

See drawings for details of shortcuts

## 4 Installation instruction

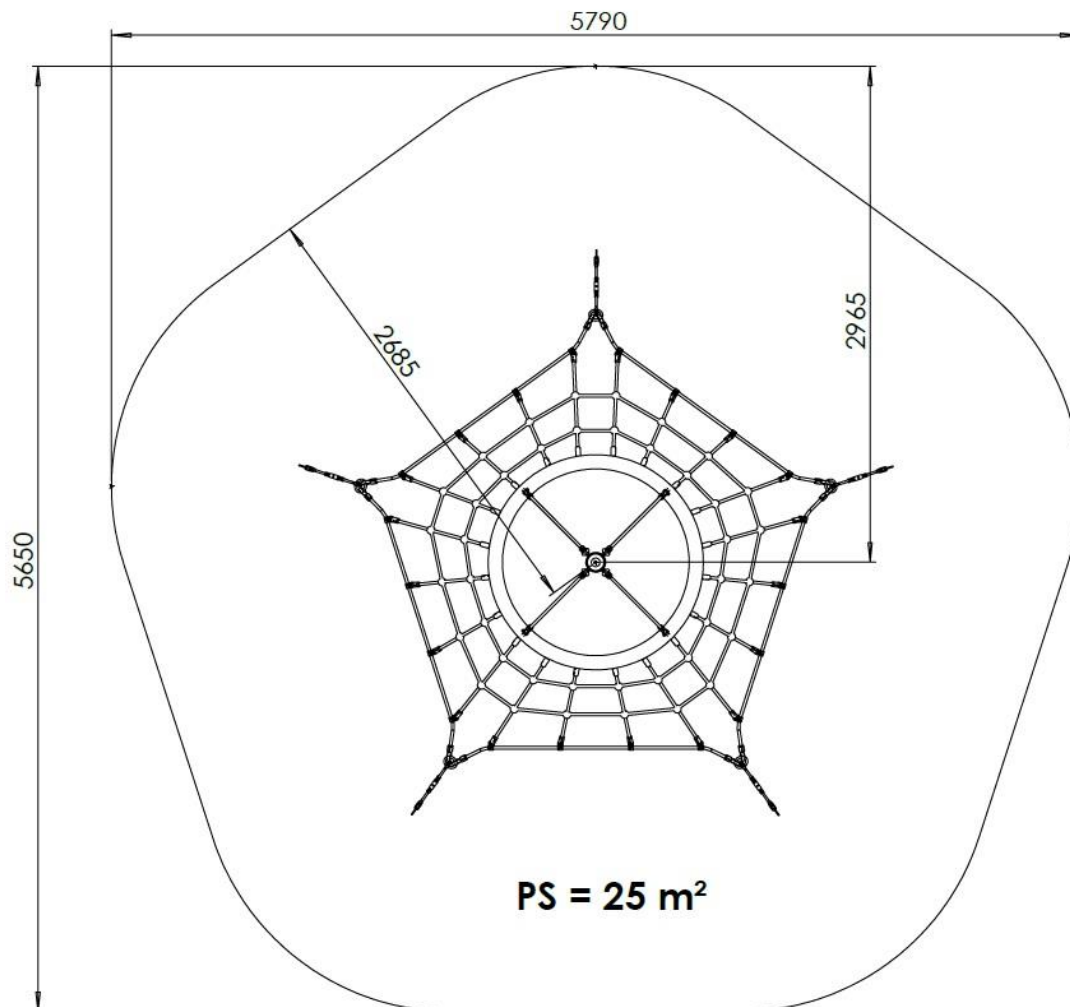

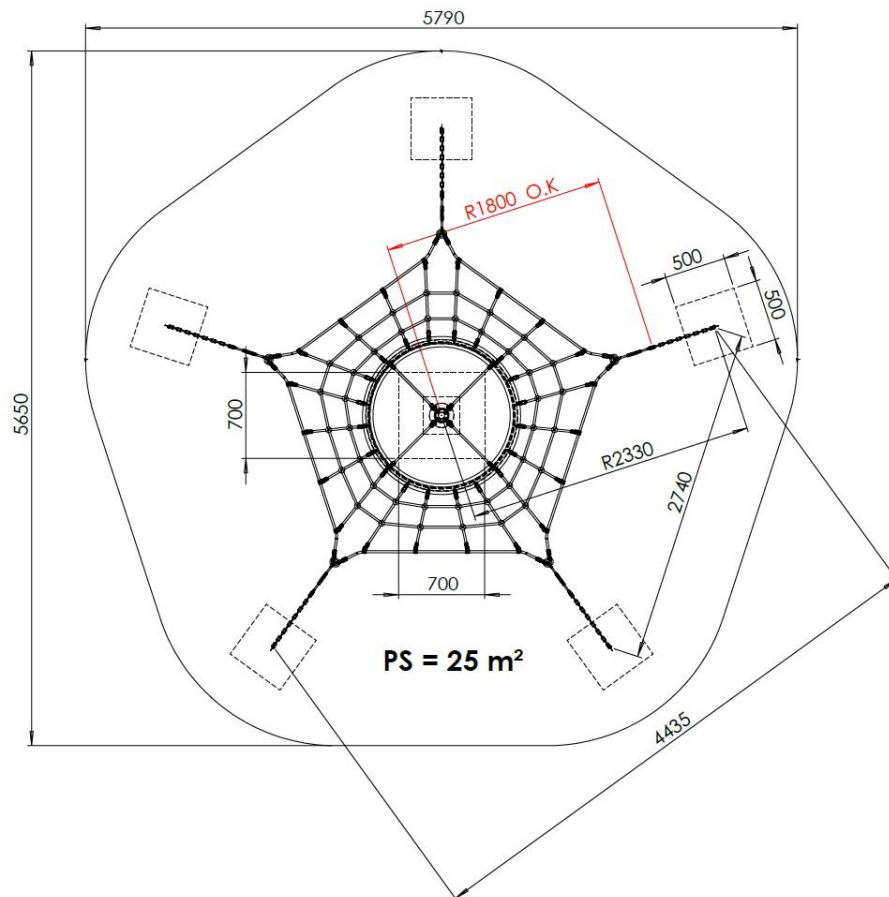
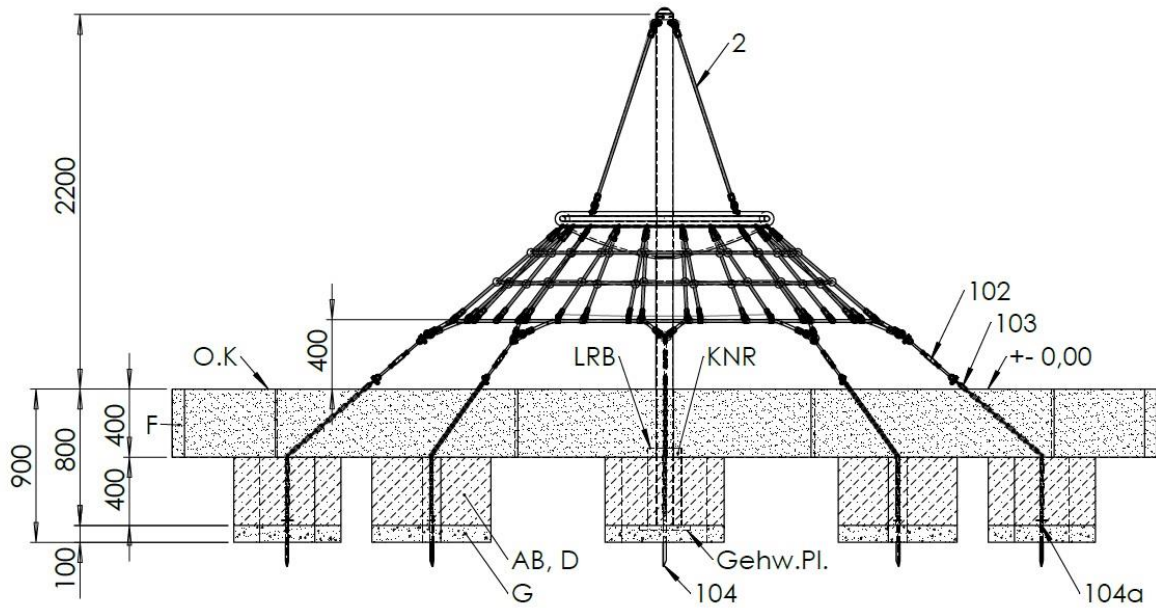

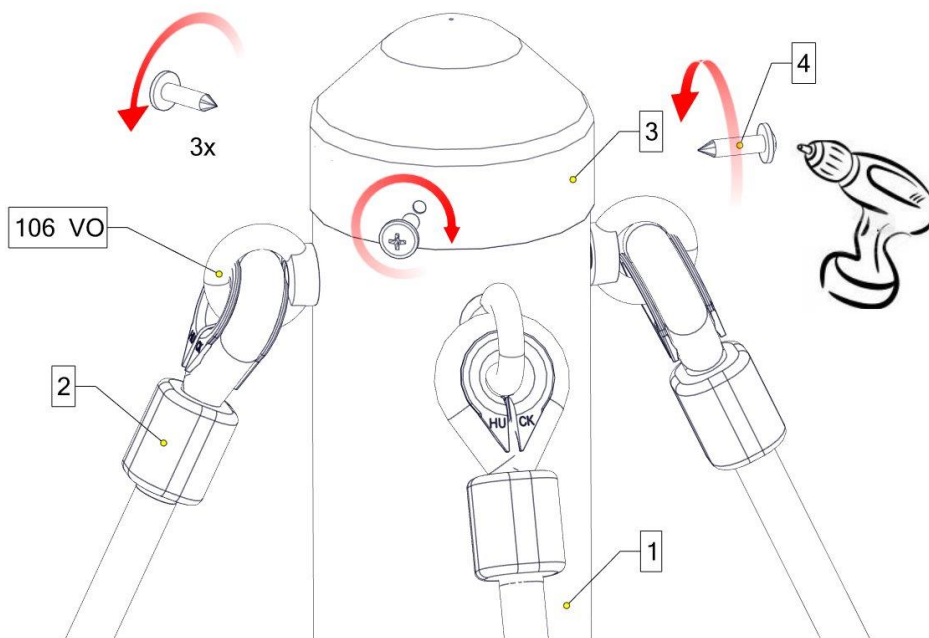
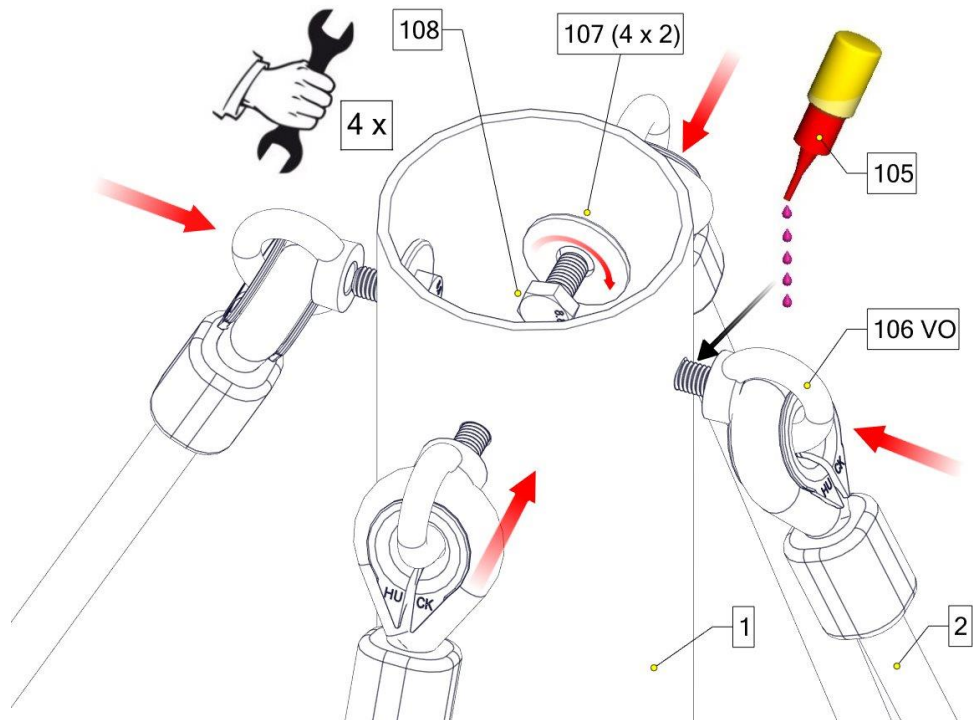

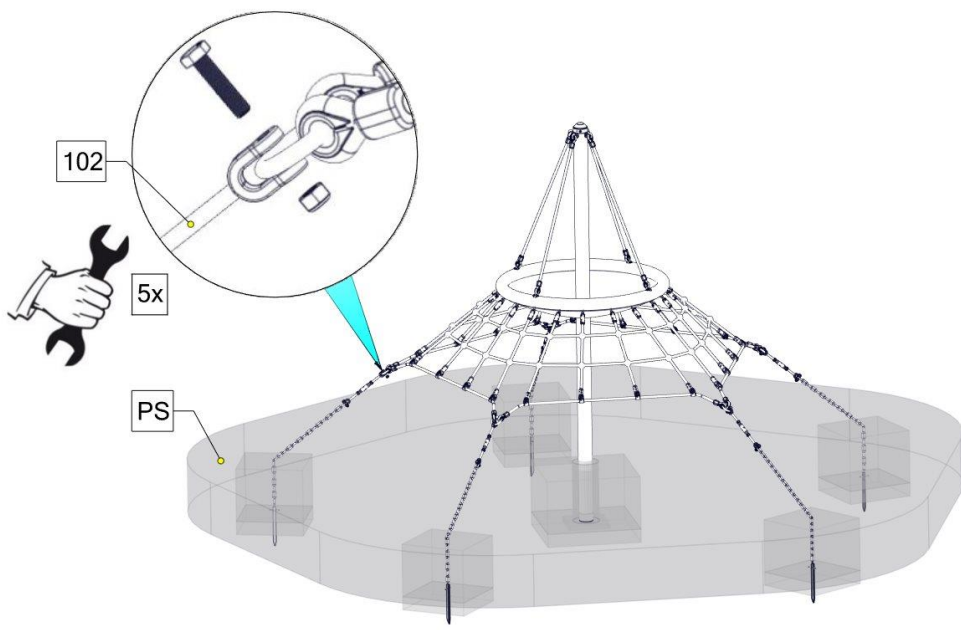
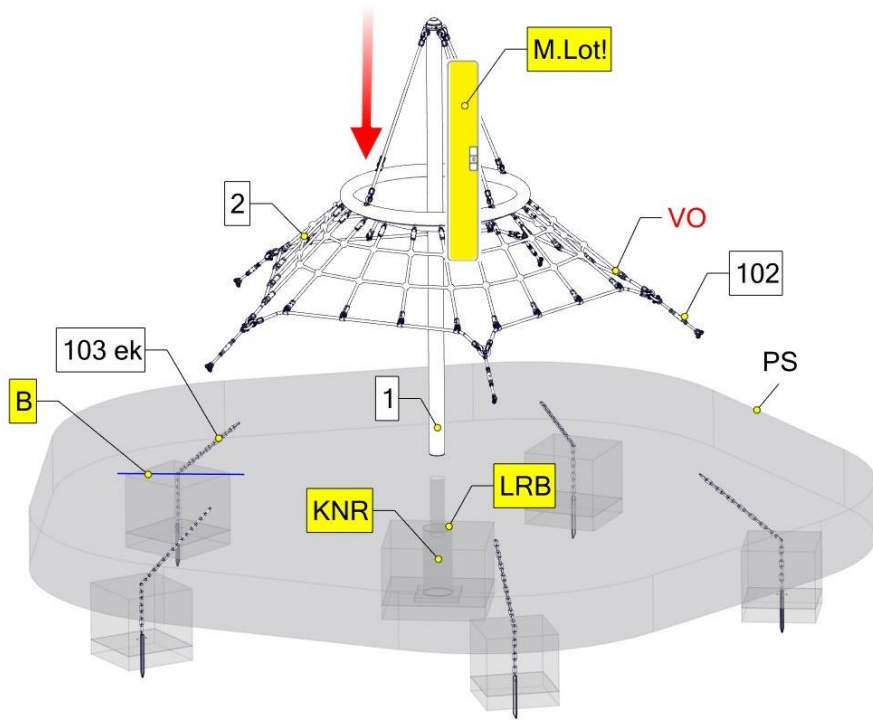

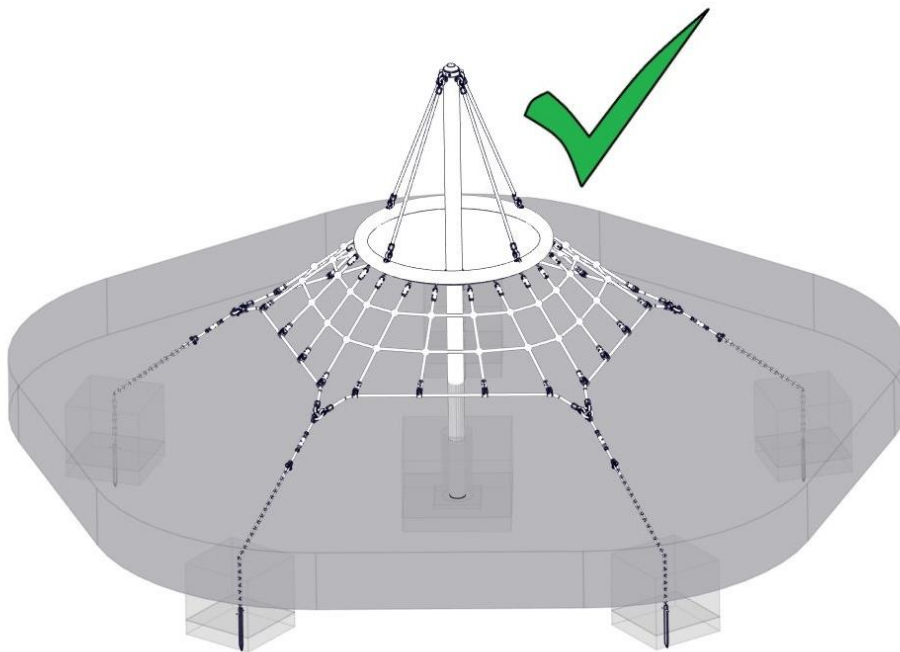
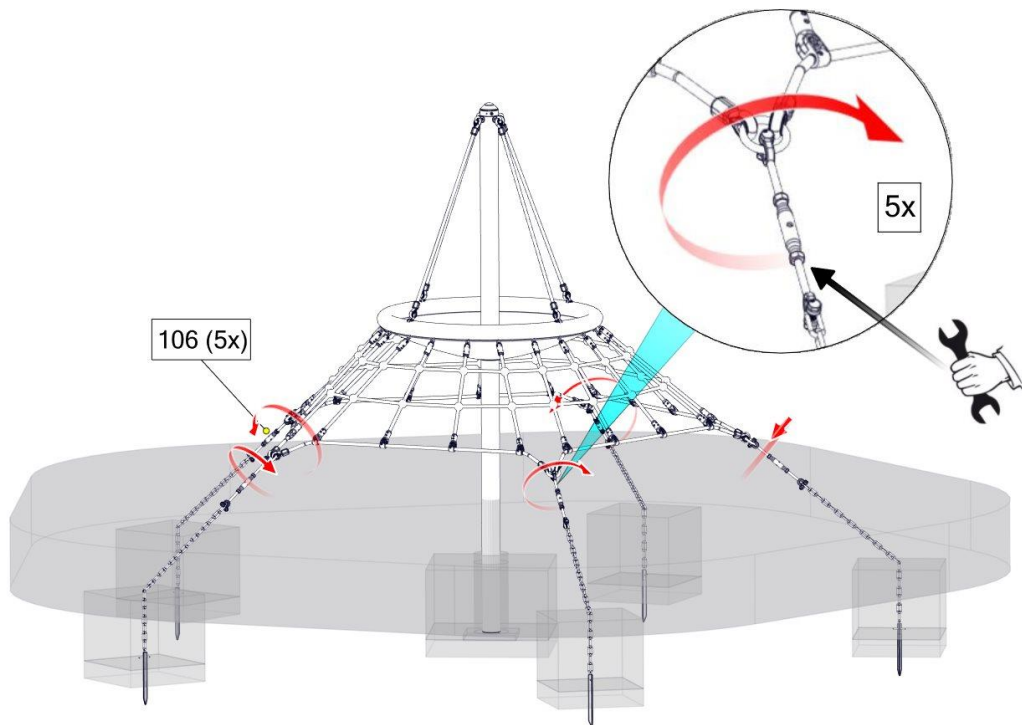

## **Screw lock!**

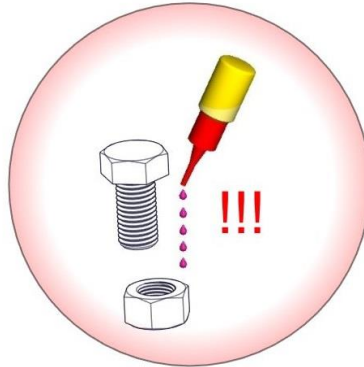

**All screws, nuts and sleeves  
Must be secured with Loctite  
(except stop nut)  
(e.g. Torx sleeves M12 x 40 with at least 5 drops.)**

## 5 Post installation checks



Make sure that the public are kept away from the equipment until it is properly installed.

### 5.1 Marking filler depth

- Labelling the posts to show the depth of material provided as fall protection (i.e. loose filler).

### 5.2 The equipment has not been installed safely in the following cases:

- Installation of equipment is not complete.
- The protective surface has not been installed yet.
- Appropriate maintenance work cannot guarantee operational safety.

### 5.3 Removal of all assembly aids

- Please make sure that all assembly aids have been removed from the playing area. The equipment must not be approved for use until this check has been carried out.

### 5.4 Information about inspection of the equipment before it is used for the first time

- There are no special inspection requirements to be met before the equipment is used for the first time.

### 5.5 Retighten bolts

- After one week of play, please retighten all bolts again. Later upon respective maintenance.



## **B Maintenance Instructions** **Dino Mini, Art.-Nr. 10.05.100**

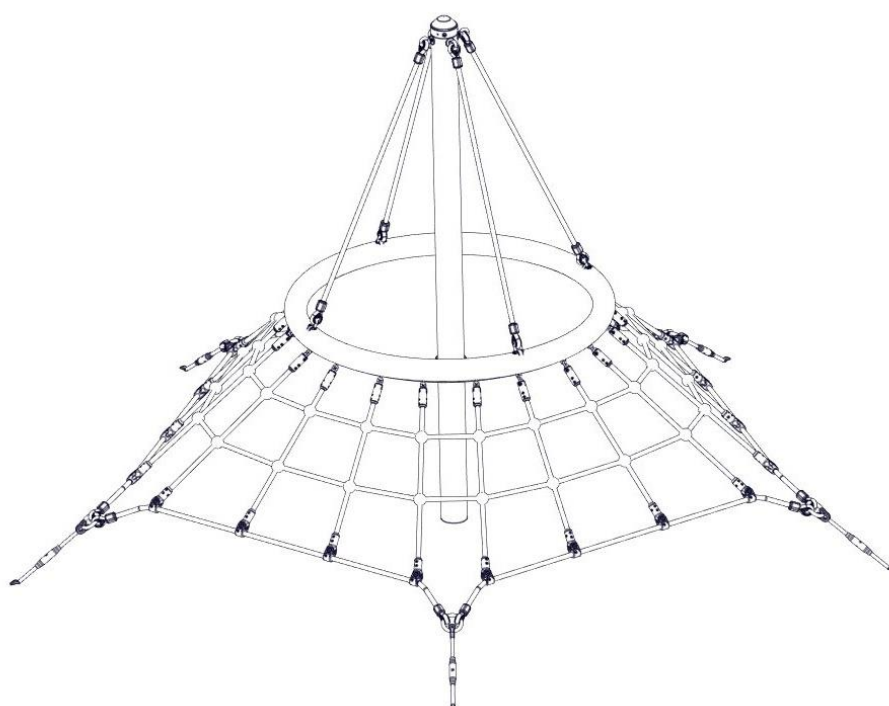

Revisionshistorie

Revision 0 – 2010-01-28  
Erste freigegebene Version

Wartungsanleitung  
Revision 05 – 2021-08-09  
neue Form der Anleitung FH

Alle Rechte vorbehalten  
© Copyright 2010 Huck Seiltechnik GmbH

---

## 6 Introduction Maintenance

### 6.1 General informations

This equipment should be installed, inspected, maintained and operated in accordance with EN 1176-7 guidelines.



**Please note:** Providing any necessary repairs are carried out, a piece of play equipment that is inspected regularly cannot become so damaged that it is dangerous.

---

Any spare parts which may be required can be obtained directly from your supplier.



This equipment should only be assembled, maintained and repaired by **persons with the necessary expertise**.  
**A copy of the inspection record should be given to the operator, who must confirm receipt.**

---

**This maintenance instruction is based on the standard  
“EN 1176-1:2017”.**

## **7 General maintenance information**

### **7.1 Maintenance intervals**

Maintenance intervals are based on average use. Please note that more frequent inspections and/or maintenance are required if the play equipment is subject to intensive use.

### **7.2 Inspection frequency**

The frequency of inspections must be based on actual use. Factors that affect frequency include vandalism, location (e.g. coastal proximity), air pollution and the age of the equipment.

### **7.3 Maintenance products and procedures**

All nuts and bolts are hot-dip galvanised or stainless steel. One of the characteristics of stainless steel is that uncontrolled cold welding may occur when the nuts are tightened. To prevent this, it is necessary to spray the nuts and bolts with Teflon spray or another similar lubricant.

### **7.4 Spare parts**

All spare parts must conform to the manufacturer's specifications.

### **7.5 Identifying spare parts**

All spare parts are listed in the parts list. The parts list follows the installation requirements.

### **7.6 Special instructions for the disposal of individual equipment components**

No special instructions are necessary.

### **7.7 Special measures during the break-in period**

No later than 2 weeks after assembly, all screwed connections should be checked and tightened if necessary.

### **7.8 Maintenance of protective surfaces**

Surfaces providing fall protection must also be maintained regularly. It is particularly important to maintain the correct level of loose surface material and add more if necessary.

---

## 7.9 Faults

---



Damages must be repaired as soon as they are detected. If serious defects that affect the safety cannot be repaired straight away, the playground item must be blocked with immediate effect.

---

## 7.10 Loose screws

---



Loose screws always cause quality problems and put safety at risk. Therefore, loose screws should always be tightened and checks carried out to ensure that there are no missing screws.

---

## 7.11 Preventing equipment use

Use of the equipment should be prevented in the event of incomplete installation, disassembly, maintenance, repairs and faults.

## 7.12 Claims/liability for faults (steel poles)

Steel posts and footings are covered by our guarantee if regular maintenance is carried out and recorded in writing.

Our general terms and conditions apply. Maintenance of steel poles first takes place after 3 years. The steel posts must be excavated down to the concrete foundations and checked for corrosion.

Zinc paint should be applied to any corroded areas and scratches.

Check ropes for abrasion, replace ropes where coating is damaged down the Steel inlet.

## 8 Maintenance timetable

### 8.1 Special advices

#### 8.1.1 Maintenance interval

We strongly advise you to carry out inspections and maintenance work within the specified periods as use of the equipment, the weather and malicious vandalism cause wear and tear that compromises the safety and function of the equipment.

#### 8.1.2 Maintenance intervals in the event of intensive use

Please note that more frequent inspections and/or maintenance are required if the play equipment is subject to intensive use.

#### 8.1.3 Faults that compromise safety

---



In the event of a fault that compromises safety, quick action must be taken. This may involve repairing it immediately or shutting down and dismantling the equipment.

---

#### 8.1.4 Faults that compromise function

---



Faults that compromise function should also be repaired immediately. Such faults lower the value of the equipment to the user and encourage malicious vandalism, which may render the equipment less safe. Any damage should also be repaired immediately.

---

## 9 Regular maintenance

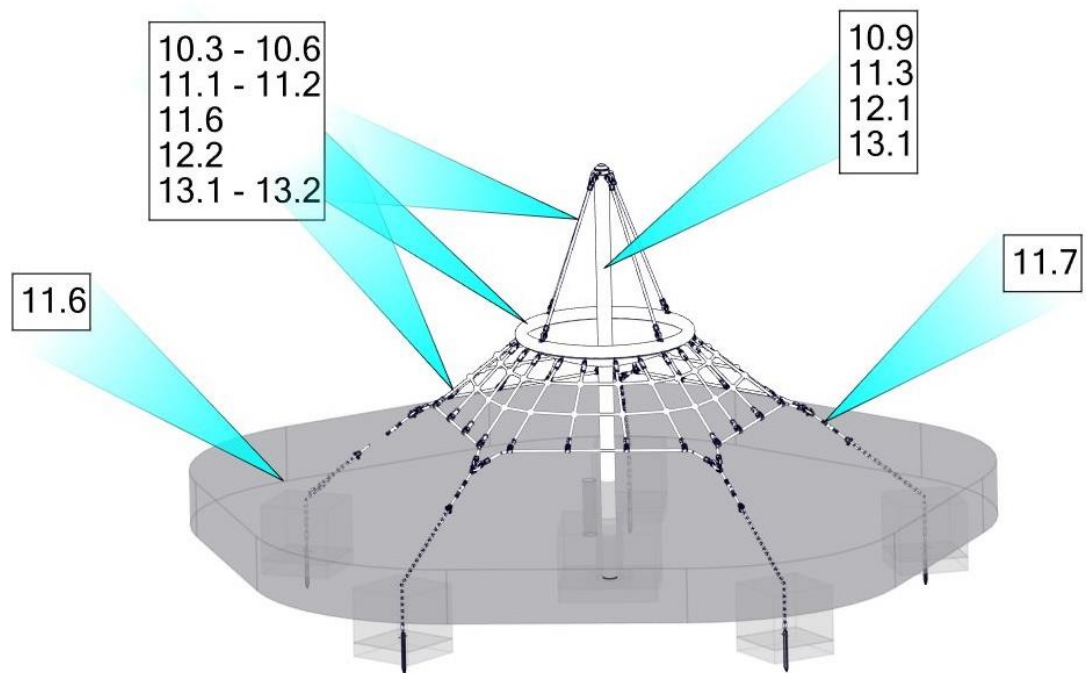

## 10 Monthly maintenance

- 10.1 Check the spaces between the equipment and the ground (clearance and height of fall).
- 10.2 Check the ground surface of fall protection for hard objects and loose foundations.
- 10.3 Check all connecting elements and fittings for wear and tear and tighten if necessary. Replace damaged or missing parts.
- 10.4 Check that moving metal parts (joints, springs, etc.) move smoothly and are not worn. Replace if necessary. It is not necessary to lubricate joints as we only use maintenance-free metal roller bearings.
- 10.5 Check all attachments such as chains, ropes, nets, etc. for damage and replace if necessary.
- 10.6 Check rubber parts, sleeves, etc. for wear and tear or damage and replace if necessary.
- 10.7 If necessary, remove excess padding material from the post footings due to danger of rotting.
- 10.8 Check the surface of wooden parts for damage caused by the weather or external influences and mould. Repair or replace if necessary.
- 10.9 Check the surface of plastic and metal parts, e.g. slides, for damage and replace if necessary.

## 11 Quarterly maintenance

- 11.1 Detailed inspection of the operation and stability of the equipment paying particular attention to any wear and tear.
- 11.2 Tighten all forms of attachment.
- 11.3 Repaint and retreat surfaces.
- 11.4 Maintenance of fall protection surfaces.
- 11.5 Lubrication of joints.
- 11.6 Check height of fall protection material and top up with loose filler if necessary. If the posts are labelled, top up to the mark.
- 11.7 Retighten all bolts.
- 11.8 Tighten the turnbuckles of the netting in three steps (crosswise) and always keep the center pole in line.

To accelerate the strain of the ropes, 1 person has to climb and jump onto the 8 tension ropes after each step of tightening.

The preliminary end tension of the pyramid is reached when the tension ropes in shoulder height will not move more than 5cm (press by thumb).

After complete tightening, lock the nuts of the turnbuckles.



---

## 12 Half yearly maintenance

- 12.1 The stability of supporting posts, supports, foundations etc. has to be checked. The safety level of the entire system has to be checked after repairs have been carried out or additional system components have been installed or replaced.



## Annual Maintenance

---

### 13 Annual maintenance

- 13.1 Ascertaining that the equipment, foundations and surfaces are safe for operation.
- 13.2 In particular, the equipment should be checked for decay and corrosion. It may be necessary to dig out or excavate certain components in order to do so. Zinc paint should be applied to corroded areas and scratches.



The equipment must be inspected by someone **with the necessary expertise** in strict compliance with the instructions issued by Huck Seiltechnik GmbH.

**A copy of the inspection record should be given to the operator, who must confirm receipt.**

---

## 14 Maintenance printout

Name of item: Dino Mini \_\_\_\_\_ / Art.-Nr. 10.05.100 \_\_\_\_\_

Location: \_\_\_\_\_

Customer or operator: \_\_\_\_\_  
(Town, Town council, Kindergarten)

Date of inspection	Inspector	O.K.	Accessible	Barrierred	Defects	Repaired by	Date

**Please copy and return once a year after main inspection has been carried out to the manufacturer by Telefax +49(0)6443/ 83 11 79! Place the confirmation form in the play equipment files.**

---

## 15 Hand over document

---



After the installation of the equipment pass the installation and maintenance documents to the operator. The operator has to receive the hand over documents. The complete filled and signed hand over document should be sent to the supplier.

---

Art.-No.: 10.05.100

Type of item: Dino Mini

Serial number: \_\_\_\_\_

**Customer or operator (Town, Town council, Kindergarten, etc.):**

\_\_\_\_\_  
\_\_\_\_\_

Competent person in charge:

\_\_\_\_\_  
\_\_\_\_\_

**Installation company (address):**

\_\_\_\_\_  
\_\_\_\_\_

Responsible assistant (assembler):

\_\_\_\_\_  
\_\_\_\_\_

Received the complete assembly instructions, maintenance instructions and maintenance printout.

\_\_\_\_\_

(Signature of operator)      (Signature of installation company)  
(Stamp)

Date: \_\_\_\_\_