

---

## **A Assembly Instructions**

### **Midi Climbing Teepee, Art.-No. 4587-22**

**Attention! Only use the assembly instructions included in the scope of delivery for the assembly, installation and maintenance of the respective equipment**

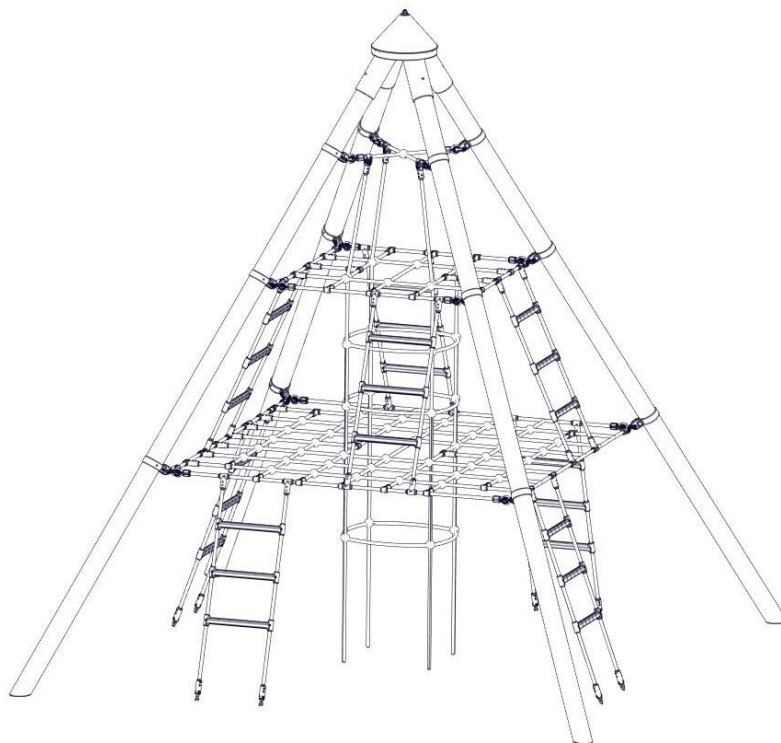

Operator: \_\_\_\_\_

Location: \_\_\_\_\_

Revision history

Revision 0 – 2012-07-09

The first allowed version

Assembly instructions

Revision 1 – 2021-01-14

Neue Form der Montageanleitung FH

All rights reserved

© Copyright 2013 Huck Seiltechnik GmbH

## Contents

<b>A</b>	<b>Assembly Instructions Midi Climbing Teepee Art. 4587-22</b> .....	<b>1</b>
1	Introduction Assembling .....	4
2	Datasheet Midi Climbing Teepee, Art. 4587-22 .....	6
3	Delivery contents (parts list with part numbers) .....	8
4	Erection instructions .....	13
5	Post installation checks .....	18
<b>B</b>	<b>Maintenance Instructions Midi Climbing Teepee</b> .....	<b>17</b>
6	Introduction Maintenance .....	19
7	General maintenance information.....	20
8	Maintenance timetable .....	22
9	Regular maintenance.....	23
10	Monthly maintenance .....	23
11	Quarterly maintenance .....	24
12	Half yearly maintenance.....	24
13	Annual maintenance.....	25
14	Maintenance printout.....	26
15	Hand over document .....	28

## List of Tables

Table 3-1: Delivery contents, in words .....	8
Table 3-2: Delivery contents, in symbols.....	9

---

## 1 Introduction Assembling

### 1.1 General information

This equipment should be installed, inspected, maintained and operated in accordance with EN1176-7 guidelines.

**Before installation work commences, please check that you have all of the equipment and fixation components in the parts list provided (see Tables 3-1 and 3-2).**

**Please consider that the installation has to be carried out only on even terrain (max.slope up to 3%).**

Any spare parts that may be required can be obtained directly from your supplier.

Please do not hesitate to call your supplier if you have any problems during installation or in case of any other questions.



**Attention**

Following installation, complete assembly instructions, maintenance instructions and a maintenance record must be sent to the operator who must confirm receipt in writing. See the last page of this document.



**Attention**

All nuts and bolts are hot-dip galvanised or stainless steel.

One of the characteristics of stainless steel is that uncontrolled cold welding may occur when the nuts are tightened. To prevent this, it is necessary to spray the nuts and bolts with Teflon spray or another similar lubricant.

---

**We hereby confirm that this play equipment has been tested and certified in accordance with the play equipment standard EN 1176.**

## **Drawings / Views**

All optical drawings are showing only the measurements/dimensions and are no mandatory technical views of the complete item.

We reserve the right to change technical details of our articles which are serving for the further development of our articles and are reasonable for the customer.

## **Measurement tolerances**

Because of the properties and characteristics of the components, minor measurement tolerances compared to the indication on the sketches are possible.

This concerns all shown measurements except the foundation measurements resp. measurements below upper edge ground level/play area.

## 2 Datasheet Midi Climbing Teepee, Art.-No. 4587-22

1. Space requirement: 3,35m x 3,35m  
safety zone: 5.90m x 5,90m  
Total height: 3.65 m  
height of fall: 2.15 m

2. Required safety surface:

Surface material	Description mm	Minimum thickness of layer mm	Maximum height of fall mm
Topsoil grass			<= 1000*
Chipped bark	20 – 80 grain size	300/400	<= 2000/3000
Wood chippings	5 – 30 grain size	300/400	<= 2000/3000
Sand	0.2 – 2 grain size	300/400	<= 2000/3000
Gravel	2 – 8 grain size	300/400	<= 2000/3000
Other ground materials	As recommended by manufacturer		

3. Name and overall dimension of the largest component:  
Steel posts (4 pieces) length 5,0m, ø 101,6 mm
4. Name and weight of the heaviest component:  
Steel posts (4 pieces), approx. 145 kg
5. Intended age group: 4 years and over
6. **Please note that this equipment is set in concrete.**  
Concrete: C25/30  
Required concrete: 1.6 m<sup>3</sup>  
Foundations/area to be excavated:  
**4 x 1,0 m long x 1.0 m wide, total depth 0.90 m including 10 cm drainage**  
Top edge of concrete 40 cm below ground level



Attention!

**Round off foundation edges (min.R = 100 mm)! Sizes of foundations are “4-5” (natural ground).**

**Soil class 4: soft to medium plasticity, interleave bound, with minor portion of stone (portion < 30% with bigger diameter of 63 mm grain size).**

**Soil class 5: ground with soil class 3 and 4 with big portion of stones (portion > 30% with bigger diameter of 63 mm grain size).**

**In case of sandy and soft soils, the surface measure of foundations have to be enlarged for about 50%!**

7. Assembly time, once foundations completed: 3 hours.  
Required assistants: 2 persons.

8. Any spare parts which may be required can be obtained directly from your supplier.
9. **We hereby confirm that this item of play equipment has been tested and certified in accordance with the play equipment standard EN 1176.**

### 3 Delivery contents (parts list with part numbers)

#### 3.1 In words

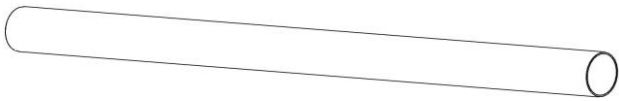
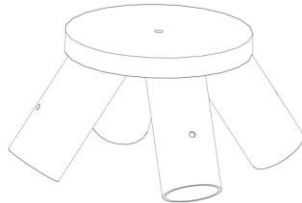

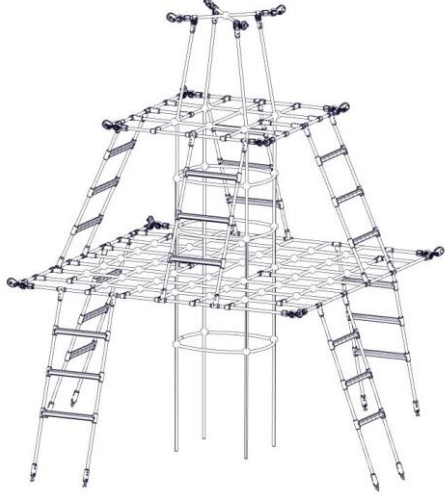



Table 3-1: Delivery contents, in words





Pos.	Quantity	Element / Description	Size	O.K.	Missing
<b>1</b>	4	Steel posts	Ø 101,6 mmx 5,00 m		
<b>2</b>	1	4-Post Connector			
<b>3</b>	1	Cover cap	Ø 360 mm		
<b>4</b>	1	Play component			
<b>100</b>	1	Threaded bolt	M16 x 165 mm VA		
<b>101</b>	1	Nut cap	For M16		
<b>102</b>	1	Nyloc nut DIN 985	M16		
<b>103</b>	1	Nut DIN 934	M16		
<b>104</b>	1	Washer DIN 9021	17 VA		
<b>105</b>	4	Self drilling screws	5,5 x 25mm		
<b>106</b>	8	Springring M6 DIN 127	B6		
<b>107</b>	12	Post Cuff with Carriage bolt and nyloc nut			
<b>108</b>	4	Post Cuff with bolt and 2x nuts			
<b>109</b>	12	Fix-anchor	M12		
<b>110</b>	12	chain adapter, stainless steel	M12		
<b>111</b>	70	Torx-screw	4,5 x 25 mm		
<b>Geh w.Pl.</b>	4	Concrete slab (by the customer)			



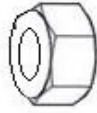

### 3.2 In symbols

Table 3-2: Delivery contents, in symbols

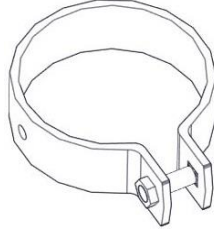
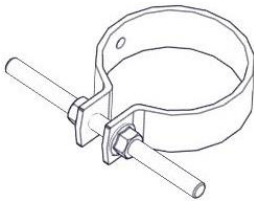
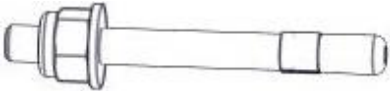
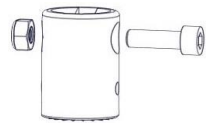
Pos.	Quantity	Symbol
1	1	 <p>Ø 101,6 mm x 5,00 m</p>
2	1	 <p>for Steelpost Ø 101,6 mm</p>
3	1	 <p>Cover cap Ø 360 mm</p>
4	1	
100	1	 <p>threaded rod M16 x 165 mm</p>
101	1	 <p>Cover cap black for M16</p>
102	1	 <p>stop nut M16 DIN 985</p>

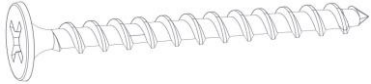
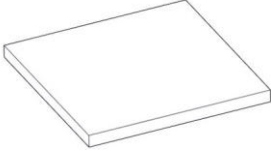
Pos.	Quantity	Symbol
103	1	 Nut DIN 934 M16
104	1	 washer 17 DIN 9021
105	1	 5,5 x 25 mm
106	4	 Springring for M6 DIN 127
107	12	 Pipe clamp
108	4	 Ground anchor
109	12	 Fix-anchor M12
110	12	 chain adapter M12, stainless steel

Pos.	Quantity	Symbol
111	70	 <p>Torx-screw 4 x 25 mm</p>
Gehw. Pl.	4	 <p>Concrete slab (by the customer)</p>

<b>Abbreviations for Midi Climbing Teepee</b>	
<b>A</b>	View
<b>AB</b>	The legally prescribed setting times must be observed!
<b>D</b>	Concrete C25/30 (for foundations)
<b>Dt.</b>	Detail view
<b>G</b>	Drainage
<b>Gehw.PI</b> 	Sidewalk flagstone (by the customer)! Upper edge – drainaget (see drawing)
<b>F</b>	Fall protection
<b>O.K</b>	Upper edge of playing level
<b>PS</b>	Safety area
 Attention!	<p><b>Round off foundation edges (min.R = 100 mm)! Sizes of foundations are designed for soils class “4-5” (natural ground).</b></p> <p><b>Soil class 4: soft to medium plasticity, interleave bound, with minor portion of stone (portion &lt; 30% with bigger diameter of 63 mm grain size).</b></p> <p><b>Soil class 5 : ground with soil class 3 and 4 with big portion of stones (portion &gt; 30% with bigger diameter of 63 mm grain size).</b></p> <p><b>In case of sandy and soft soils, the surface measure of foundations have to be enlarged for about 50%!</b></p>

See drawings for details of shortcuts

## 4 Erection instructions

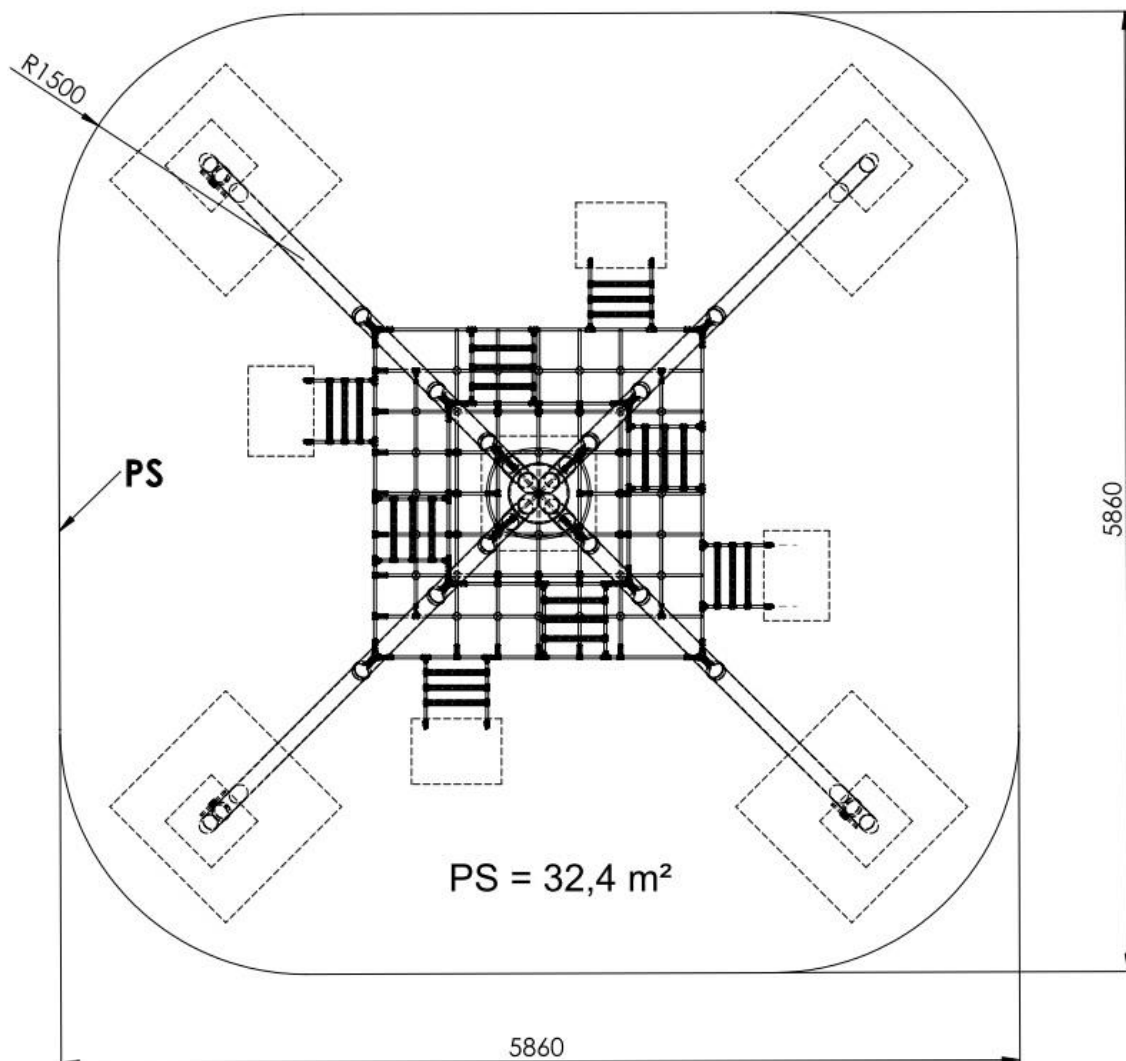

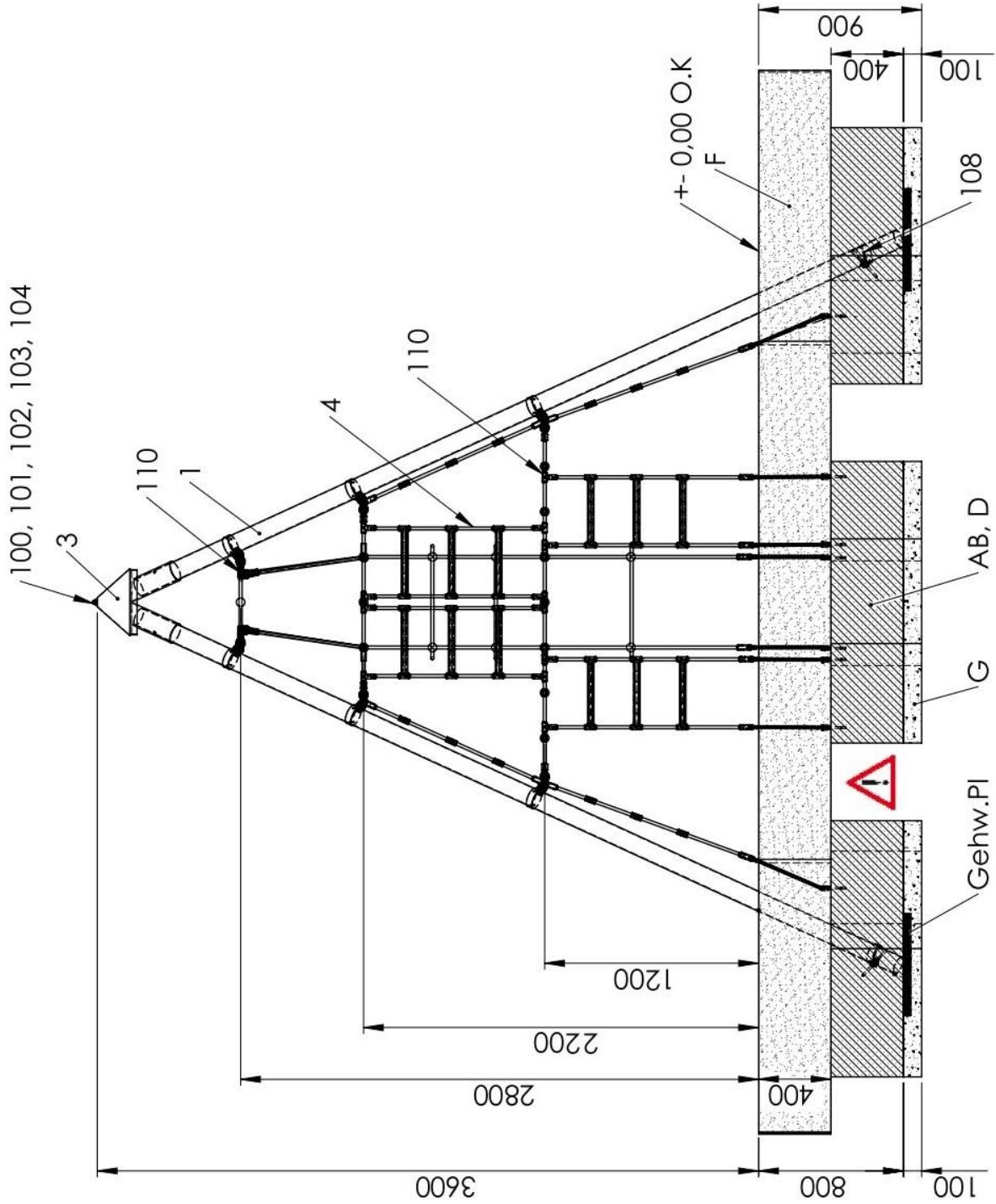

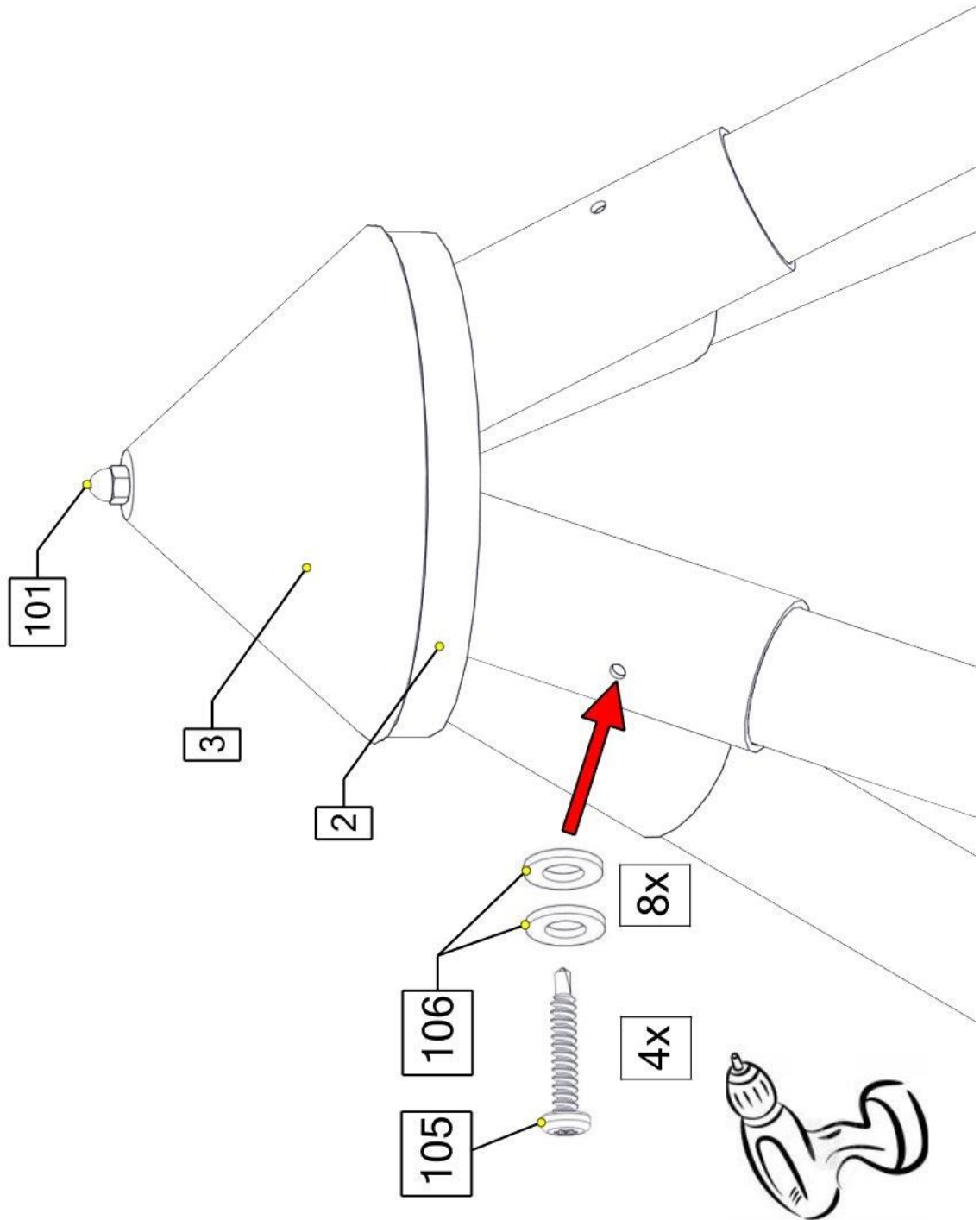

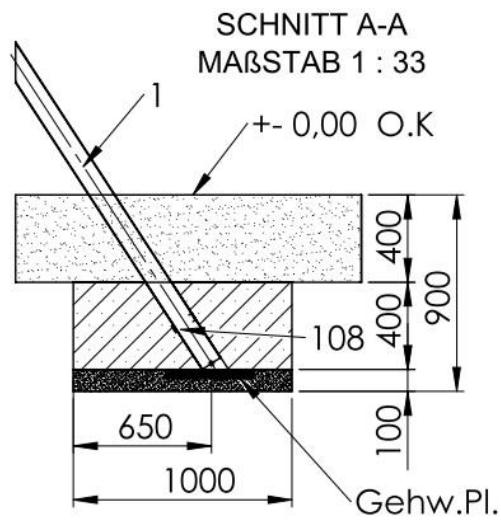
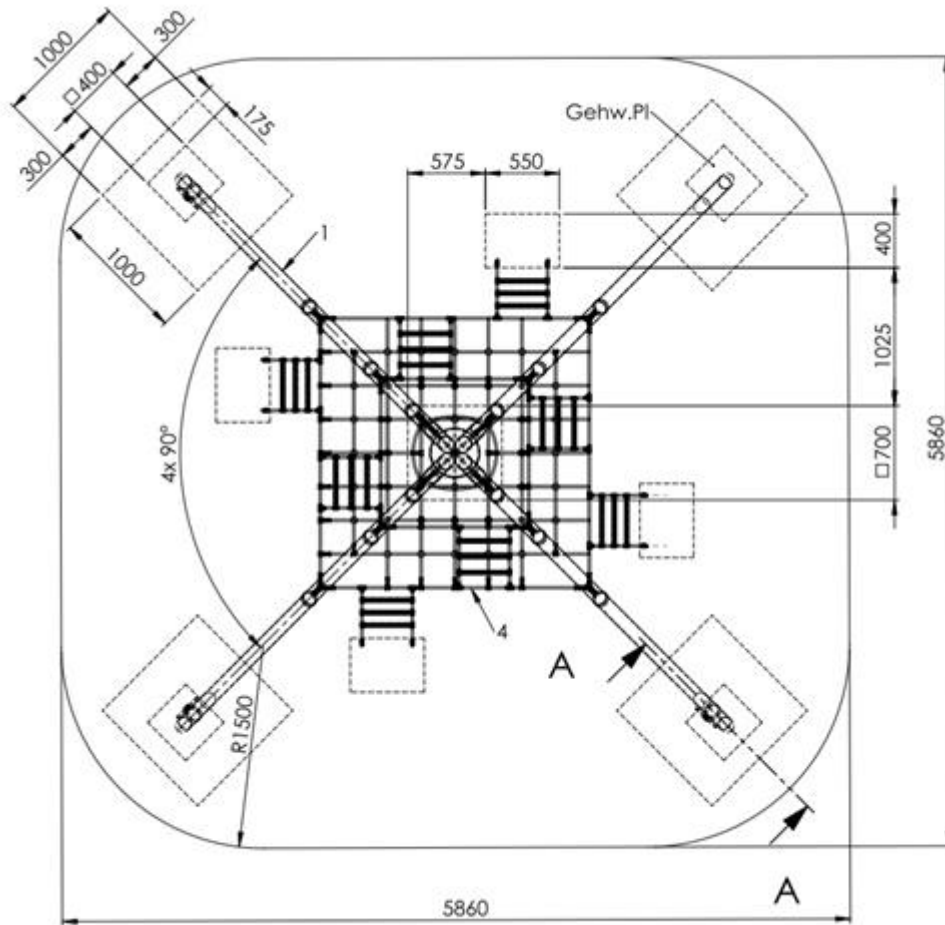





---

## 5 Post installation checks

---



If the equipment has not been installed safely, you must ensure that the public is prevented from using it.

---

### 5.1 Marking filler depth

- Labelling the posts to show the depth of material provided as fall protection (i.e. loose filler).

### 5.2 The equipment has not been installed safely in the following cases:

- Installation of equipment is not complete.
- The protective surface has not been installed yet.
- Appropriate maintenance work cannot guarantee operational safety.

### 5.3 Removal of all assembly aids

- Please make sure that all assembly aids have been removed from the playing area. The equipment must not be approved for use until this check has been carried out.

### 5.4 Information about inspection of the equipment before it is used for the first time

- There are no special inspection requirements to be met before the equipment is used for the first time.

### 5.5 Retighten bolts

- After one week of play, please retighten all bolts again. Later upon respective maintenance.

---

## **B Maintenance Instructions** **Midi Climbing Teepee, Art.-No. 4587-22**

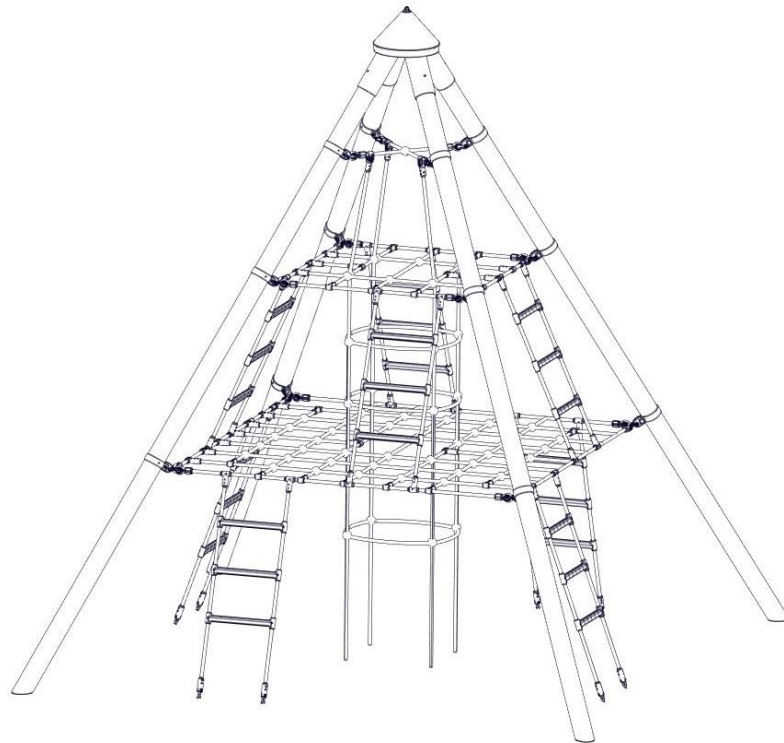

Revision history

Revision 0 – 2012-07-09

The first allowed version

maintenance instructions

Revision 1 – 2021-01-14

Neue Form der Montageanleitung FH

All rights reserved

© Copyright 2013 Huck Seiltechnik GmbH

---

## 6 Introduction Maintenance

### 6.1 General informations

This equipment should be installed, inspected, maintained and operated in accordance with EN 1176-7 guidelines.



**Please note:** Providing any necessary repairs are carried out, a piece of play equipment that is inspected regularly cannot become so damaged that it is dangerous.

---

Any spare parts which may be required can be obtained directly from your supplier.



This equipment should only be assembled, maintained and repaired by **persons with the necessary expertise**.

**A copy of the inspection record should be given to the operator, who must confirm receipt.**

---

**This maintenance instruction is based on the standard  
“EN 1176-1:2017”.**

## **7 General maintenance information**

### **7.1 Maintenance intervals**

Maintenance intervals are based on average use. Please note that more frequent inspections and/or maintenance are required if the play equipment is subject to intensive use.

### **7.2 Inspection frequency**

The frequency of inspections must be based on actual use. Factors that affect frequency include vandalism, location (e.g. coastal proximity), air pollution and the age of the equipment.

### **7.3 Maintenance products and procedures**

All nuts and bolts are hot-dip galvanised or stainless steel. One of the characteristics of stainless steel is that uncontrolled cold welding may occur when the nuts are tightened. To prevent this, it is necessary to spray the nuts and bolts with Teflon spray or another similar lubricant.

### **7.4 Spare parts**

All spare parts must conform to the manufacturer's specifications.

### **7.5 Identifying spare parts**

All spare parts are listed in the parts list. The parts list follows the installation requirements.

### **7.6 Special instructions for the disposal of individual equipment components**

No special instructions are necessary.

### **7.7 Special measures during the break-in period**

No later than 2 weeks after assembly, all screwed connections should be checked and tightened if necessary.

### **7.8 Maintenance of protective surfaces**

Surfaces providing fall protection must also be maintained regularly. It is particularly important to maintain the correct level of loose surface material and add more if necessary.

---

## 7.9 Faults

---



Damages must be repaired as soon as they are detected. If serious defects that affect the safety cannot be repaired straight away, the playground item must be blocked with immediate effect.

---

## 7.10 Loose screws

---



Loose screws always cause quality problems and put safety at risk. Therefore, loose screws should always be tightened and checks carried out to ensure that there are no missing screws.

---

## 7.11 Preventing equipment use

Use of the equipment should be prevented in the event of incomplete installation, disassembly, maintenance, repairs and faults.

## 7.12 Claims/liability for faults (steel poles)

Steel posts and footings are covered by our guarantee if regular maintenance is carried out and recorded in writing.

Our general terms and conditions apply. Maintenance of steel poles first takes place after 3 years. The steel posts must be excavated down to the concrete foundations and checked for corrosion.

Zinc paint should be applied to any corroded areas and scratches.

Check ropes for abrasion, replace ropes where coating is damaged down the Steel inlet.

---

## 8 Maintenance timetable

### 8.1 Special advices

#### 8.1.1 Maintenance interval

We strongly advise you to carry out inspections and maintenance work within the specified periods as use of the equipment, the weather and malicious vandalism cause wear and tear that compromises the safety and function of the equipment.

#### 8.1.2 Maintenance intervals in the event of intensive use

Please note that more frequent inspections and/or maintenance are required if the play equipment is subject to intensive use.

#### 8.1.3 Faults that compromise safety



In the event of a fault that compromises safety, quick action must be taken. This may involve repairing it immediately or shutting down and dismantling the equipment.

---

#### 8.1.4 Faults that compromise function



Faults that compromise function should also be repaired immediately. Such faults lower the value of the equipment to the user and encourage malicious vandalism, which may render the equipment less safe. Any damage should also be repaired immediately.

---



## 9 Regular maintenance

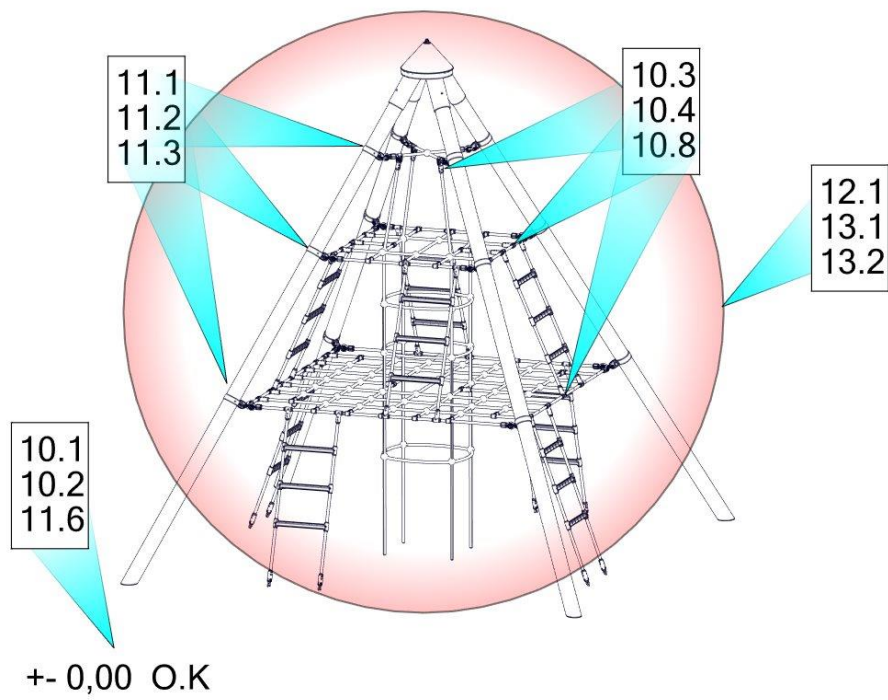

## **Regular maintenance work**

### **10 Monthly maintenance**

- 10.1 Check the spaces between the equipment and the ground (clearance and height of fall).
- 10.2 Check the ground surface of fall protection for hard objects and loose foundations.
- 10.3 Check all connecting elements and fittings for wear and tear and tighten if necessary. Replace damaged or missing parts.
- 10.4 Check that moving metal parts (joints, springs, etc.) move smoothly and are not worn. Replace if necessary. It is not necessary to lubricate joints as we only use maintenance-free metal roller bearings.
- 10.5 Check all attachments such as chains, ropes, nets, etc. for damage and replace if necessary.
- 10.6 Check rubber parts, sleeves, etc. for wear and tear or damage and replace if necessary.
- 10.7 If necessary, remove excess padding material from the post footings due to danger of rotting.
- 10.8 Check the surface of wooden parts for damage caused by the weather or external influences and mould. Repair or replace if necessary.
- 10.9 Check the surface of plastic and metal parts, e.g. slides, for damage and replace if necessary.

### **11 Quarterly maintenance**

- 11.1 Detailed inspection of the operation and stability of the equipment paying particular attention to any wear and tear.
- 11.2 Tighten all forms of attachment.
- 11.3 Repaint and retreat surfaces.
- 11.4 Maintenance of fall protection surfaces.
- 11.5 Lubrication of joints.
- 11.6 Check height of fall protection material and top up with loose filler if necessary. If the posts are labelled, top up to the mark.
- 11.7 Retighten all bolts.

### **12 Half yearly maintenance**

- 12.1 The stability of supporting posts, supports, foundations etc. has to be checked. The safety level of the entire system has to be checked after repairs have been carried out or additional system components have been installed or replaced.



## Annual Maintenance

---

### 13 Annual maintenance

- 13.1 Ascertaining that the equipment, foundations and surfaces are safe for operation.
- 13.2 In particular, the equipment should be checked for decay and corrosion. It may be necessary to dig out or excavate certain components in order to do so. Zinc paint should be applied to corroded areas and scratches.



The equipment must be inspected by someone **with the necessary expertise** in strict compliance with the instructions issued by Huck Seiltechnik GmbH.

**A copy of the inspection record should be given to the operator, who must confirm receipt.**

---

## 14 Maintenance printout

Name of item: Midi Climbing Teepee \_\_\_\_\_ / Art. No. 4587-22 \_\_\_\_\_

Location: \_\_\_\_\_

Customer or operator: \_\_\_\_\_  
 (Town, Town council, Kindergarten)

Date of inspection	Inspector	O.K.	Accessible	Barriered	Defects	Repaired by	Date

**Please copy and return once a year after main inspection has been carried out to the manufacturer by Telefax +49(0)6443/ 83 11 79!**  
**Place the confirmation form in the play equipment files.**



## 15 Hand over document



After the installation of the equipment pass the installation and maintenance documents to the operator. The operator has to receive the hand over documents. The complete filled and signed hand over document should be sent to the supplier.

Art.-No.: 4587-22

Type of item: Midi Climbing Teepee

Serial number: \_\_\_\_\_

**Customer or operator (Town, Town council, Kindergarten, etc.):**

\_\_\_\_\_  
\_\_\_\_\_

Competent person in charge:

\_\_\_\_\_  
\_\_\_\_\_

**Installation company (address):**

\_\_\_\_\_  
\_\_\_\_\_

Responsible assistant (assembler):

\_\_\_\_\_  
\_\_\_\_\_

Received the complete assembly instructions, maintenance instructions and maintenance printout.

\_\_\_\_\_

(Signature of operator)      (Signature of installation company)  
(Stamp)

Date: \_\_\_\_\_